

MATERIALS
 METAL SHIELD: COPPER ALLOY
 SPRING: COPPER ALLOY

PART NUMBER:
 F11AK - 0 C - 1 3
 SERIES ————— TRAY PACKAGE



| TOLERANCES | |
|------------|-----------|
| X.±0.40 | .XX±0.20 |
| .X±0.30 | .XXX±0.10 |

| | | | |
|------|---|-------------|---------------|
| REV. | A | DRAWN BY | Kiki 2023/5/9 |
| | | APPROVED BY | Lion 2023/5/9 |

| | | | | |
|----------|---|------|----|-------|
| TITLE | SFP PLUS CAGE, R/A, METAL SHIELD, PRESS FIT WITH SPRING | | | |
| DRAW NO. | F11AK-003 | UNIT | MM | Sheet |
| | | | | 1/3 |

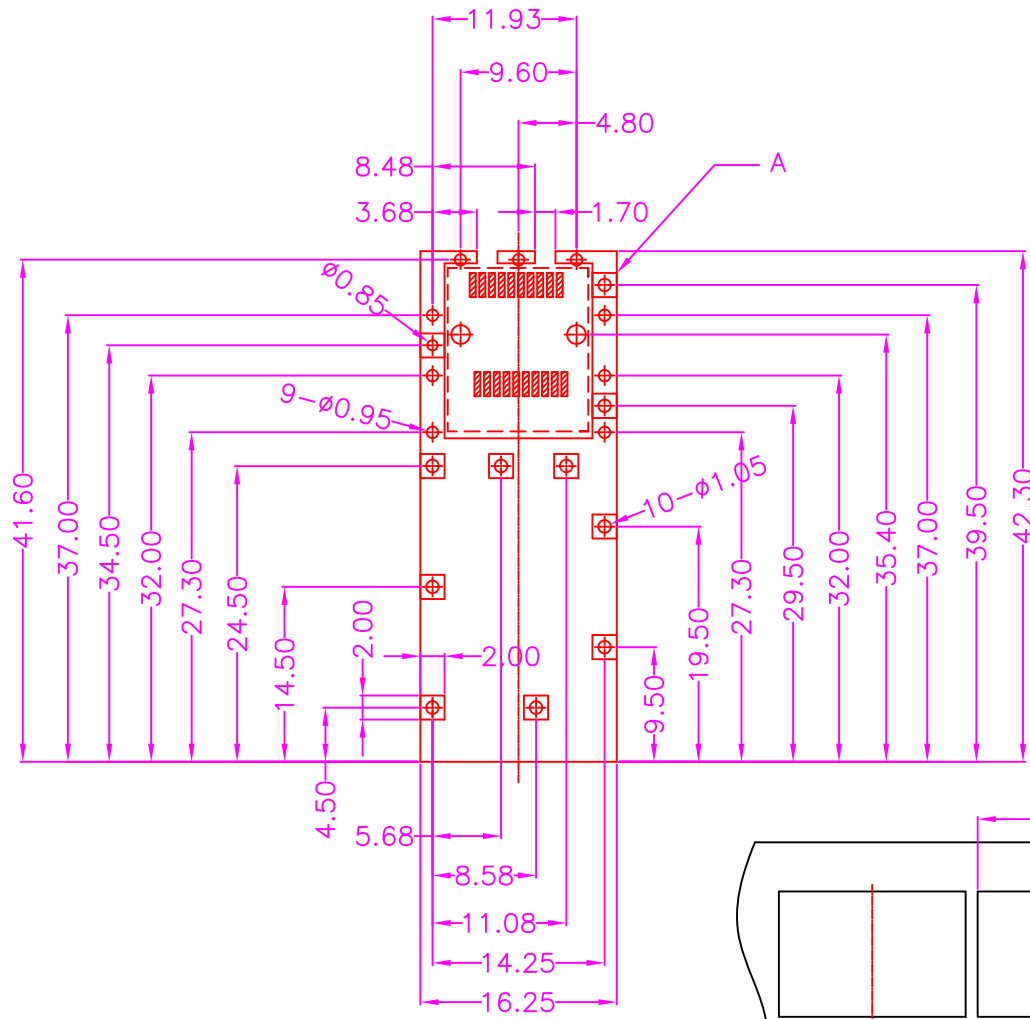

P.C.B LAYOUT
TOP VIEW ±0.05

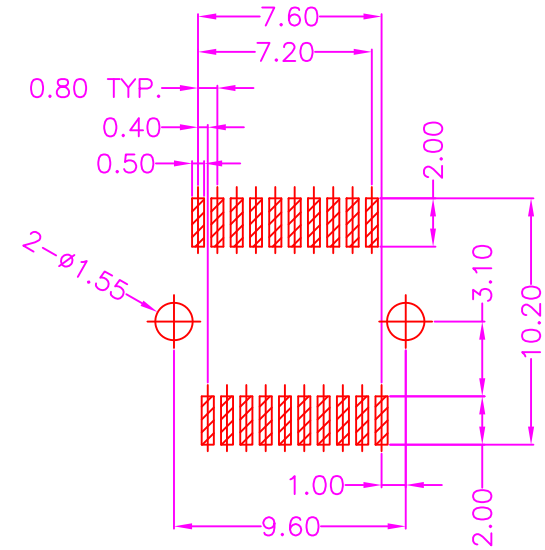

DETAIL A
SCALE 2:1

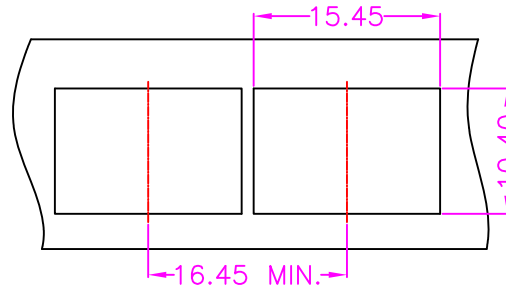

RECOMMENDED PANEL CUTOUT AND PC BOARD
PANEL POSITION AND THICKNESS 0.8-2.6

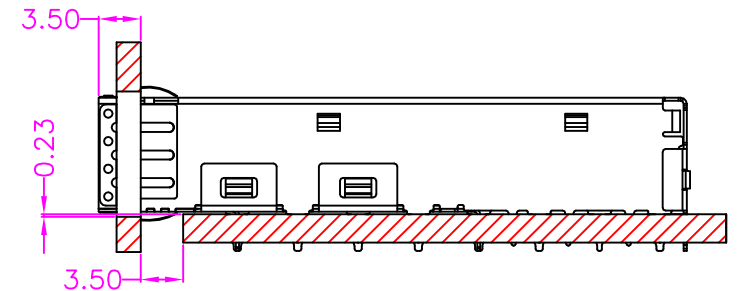

BEZEL OPENING
BELOW TOP OF PCB

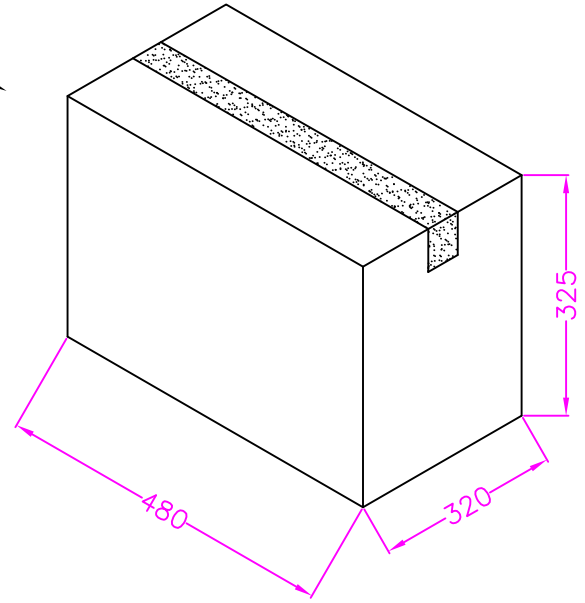
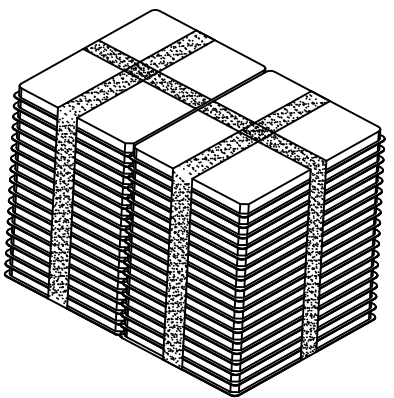
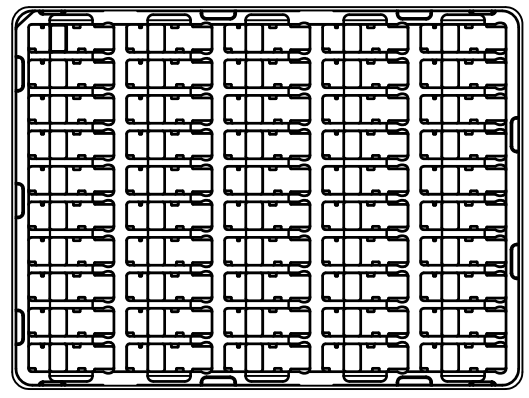

NOTE: 50PCS/ TRAY, 1700PCS/ 34 TRAYS/ CARTON



| TOLERANCES | |
|------------|-----------|
| X.±0.40 | .XX±0.20 |
| .X±0.30 | .XXX±0.10 |

| | | | | | | | | | |
|------|---|-------------|---------------|----------|---|------|----|-------|-----|
| REV. | A | DRAWN BY | KiKi 2023/5/9 | TITLE | SFP PLUS CAGE, R/A, METAL SHIELD, PRESS FIT WITH SPRING | | | | |
| | | APPROVED BY | Lion 2023/5/9 | DRAW NO. | F11AK-003 | UNIT | MM | Sheet | 3/3 |