

MATERIALS
 METAL SHIELD: COPPER ALLOY
 SPRING: COPPER ALLOY
 BELLY PCB GASKETS: MICROWAVE ABSORBING ELASTOMERS

PART NUMBER:
F11KJ - 0 C - 1 1
 SERIES ————— TRAY PACKAGE

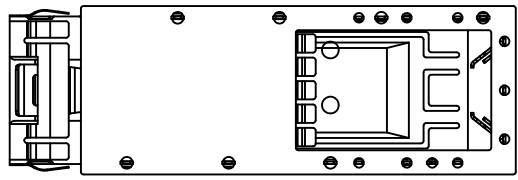

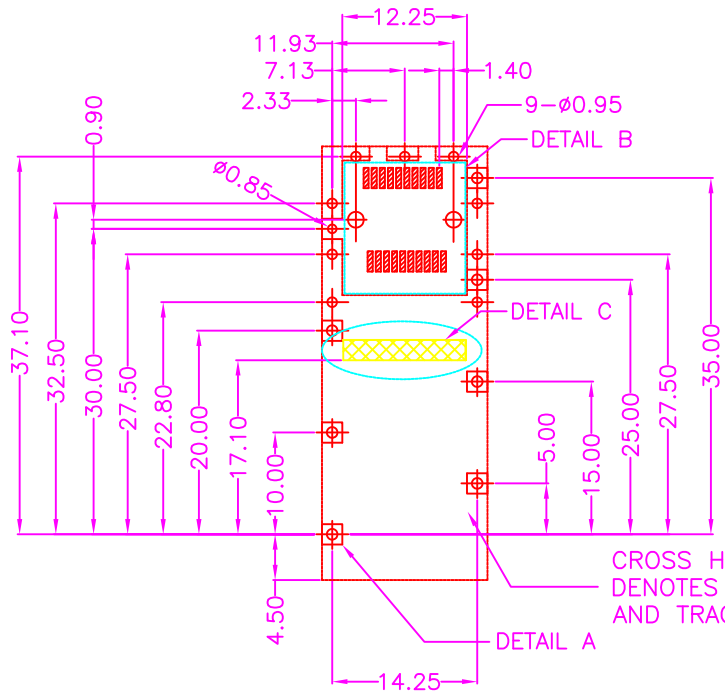

P.C.B LAYOUT
TOP VIEW ±0.05

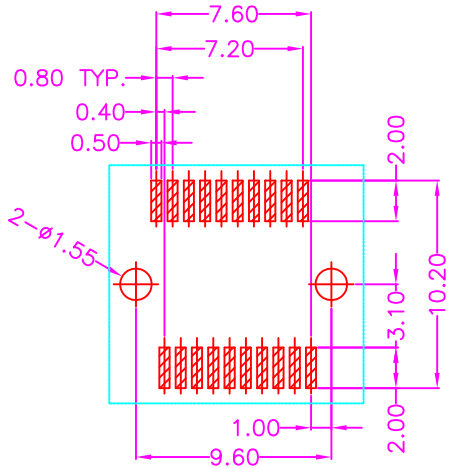

DETAIL B
SCALE 2:1

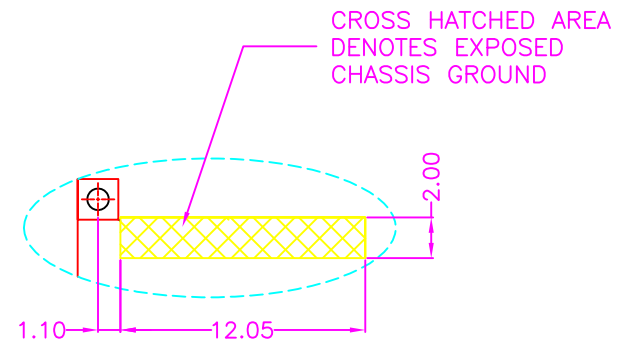

DETAIL C
SCALE 2:1

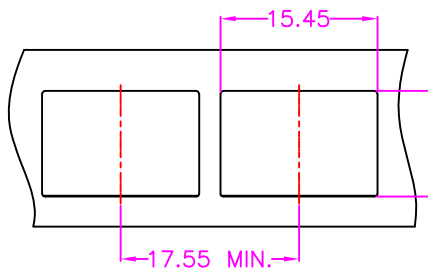

RECOMMENDED PANEL CUTOUT AND PC BOARD
PANEL POSITION AND THICKNESS 0.8-2.6

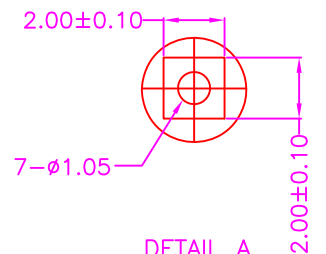

DETAIL A
SCALE 2:1

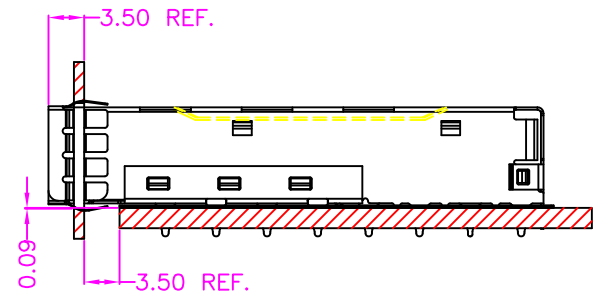

BEZEL OPENING
BELOW TOP OF PCB