

P.C.B. LAYOUT  
TOP VIEW ±0.05

**MATERIALS**

HOUSING: LCP (UL 94V-0), BLUE  
 SHELL: STAINLESS STEEL, NICKEL PLATING  
 TERMINAL: COPPER ALLOY, GOLD PLATED ON CONTACT AREA  
 TIN PLATING ON SOLDER TAIL

**SPECIFICATION**

CURRENT RATING:  
 1.8A FOR VBUS AND GND CONTACTS  
 0.25A FOR ALL THE OTHERS CONTACTS  
 DIELECTRIC WITHSTANDING: 100V AC FOR ONE MINUTE  
 CONTACT RESISTANCE:  
 30m OHMS MAX INITIAL FOR VBUS AND GND CONTACTS  
 50m OHMS MAX INITIAL FOR ALL OTHER CONTACTS  
 INSULATION RESISTANCE: 100M OHMS MIN AT DC 500V  
 OPERATION TEMPERATURE: -40°C~+85°C

**PART NUMBER:**

BUSEA - 0 9 \* T - 1 1 5

SERIES ————  
 NO. OF POS. ————  
 TIN PLATING ON SOLDER TAIL ————  
 TRAY PACKAGE

**CONTACT PLATED OPTION**

- 1: GOLD FLASH
- 3: 3u" GOLD
- 5: 5u" GOLD
- 6: 10u" GOLD
- 7: 15u" GOLD
- 9: 30u" GOLD

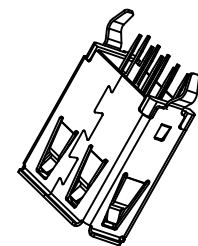

Pin NUMBER	SIGNAL NAME
1	VBUS
2	D-
3	D+
4	GND
5	StdA_SSRX-
6	StdA_SSRX+
7	GND_DRAIN
8	StdA_SSTX-
9	StdA_SSTX+
Shell	Shield



TOLERANCES

X.±0.40	.XX±0.20
.X±0.30	.XXX±0.10

REV.	A	DRAWN BY	Zhong 2020/10/26
		APPROVED BY	Lion 2020/10/26

TITLE	USB 3.0 A TYPE, PCB MOUNT, VERTICAL, METAL SHIELD, H=14.95mm, FEMALE				
DRAW NO.	BUSEA-005	UNIT	MM	Sheet	1/2

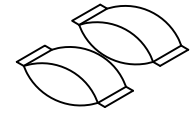
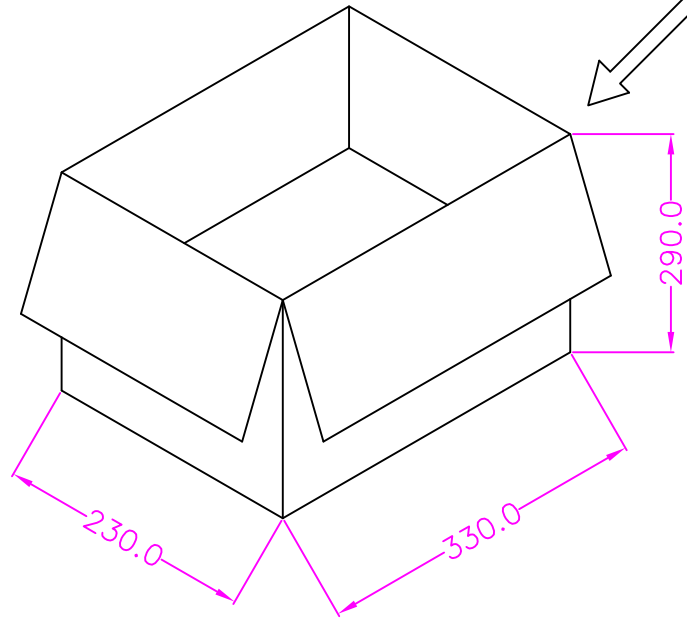
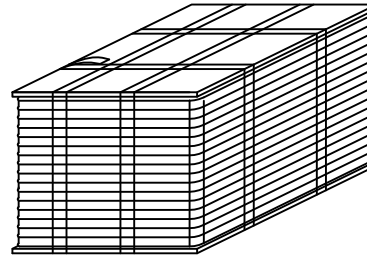
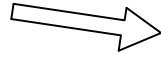
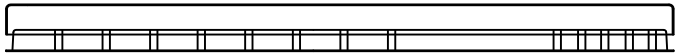
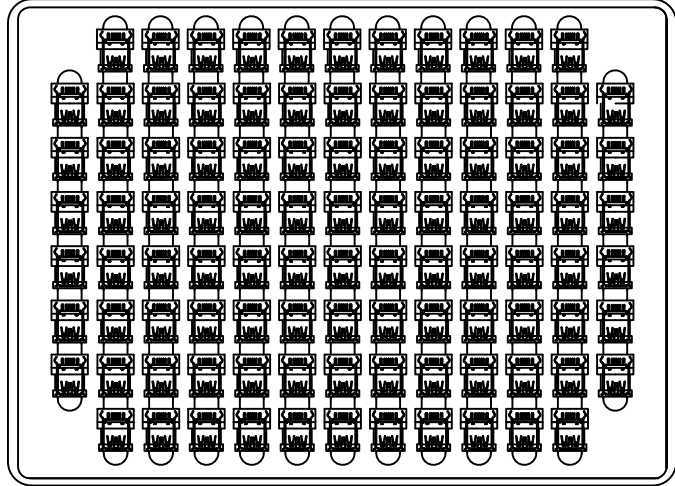

DRY BAG

NOTE: 100PCS/TRAY, 3200PCS, 32 TRAY/CARTON



TOLERANCES  
 X.±0.40 .XX±0.20  
 .X±0.30 .XXX±0.10

REV.	A	DRAWN BY	Zhong 2020/10/26
		APPROVED BY	Lion 2020/10/26

TITLE	USB 3.0 A TYPE, PCB MOUNT, VERTICAL, METAL SHIELD, H=14.95mm, FEMALE				
DRAW NO.	BUSEA-005	UNIT	MM	Sheet	2/2