

SOLDER AREA
 NO WIRE AREA

P.C.B. LAYOUT
TOP VIEW ±0.05

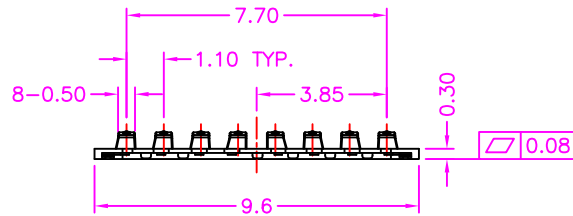

MATERIALS
 HOUSING: HI-TEMP. PLASTIC (UL 94V-0), BLACK
 TERMINAL: COPPER ALLOY, GOLD PLATED

SPECIFICATION
 CURRENT RATING: 0.5 AMP MAX
 DIELECTRIC WITHSTANDING: 500V AC FOR ONE MINUTE
 CONTACT RESISTANCE: 100m OHMS MAX
 INSULATION RESISTANCE: 1000M OHMS MIN AT DC 500V
 OPERATION TEMPERATURE: -40°C~+80°C

PART NUMBER:
MMCKL - 0 8 * - 1 2 1

SERIES — NO. OF POS. — TAPE REEL PACKAGE

TERMINAL PLATED OPTION

- 1: GOLD FLASH
- 3: 3u" GOLD
- 5: 5u" GOLD
- 6: 10u" GOLD
- 7: 15u" GOLD
- 9: 30u" GOLD

PIN No.	FUNCTION
PIN 1	DAT2
PIN 2	CD/DAT3
PIN 3	CMD
PIN 4	VDD
PIN 5	CLK
PIN 6	VSS
PIN 7	DAT0
PIN 8	DAT1



TOLERANCES

X.±0.40	.XX±0.20
.X±0.30	.XXX±0.10

REV.	A	DRAWN BY	Frank 2019/6/6	TITLE	MICRO SD, PCB MOUNT, SMT, ALL PLASTIC, H=0.30mm				
		APPROVED BY	Lion 2019/6/6	DRAW NO.	MMCKL-001	UNIT	MM	Sheet	1/2

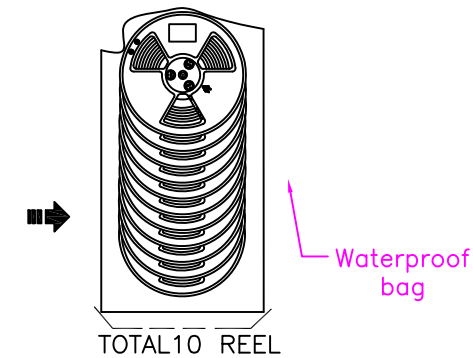
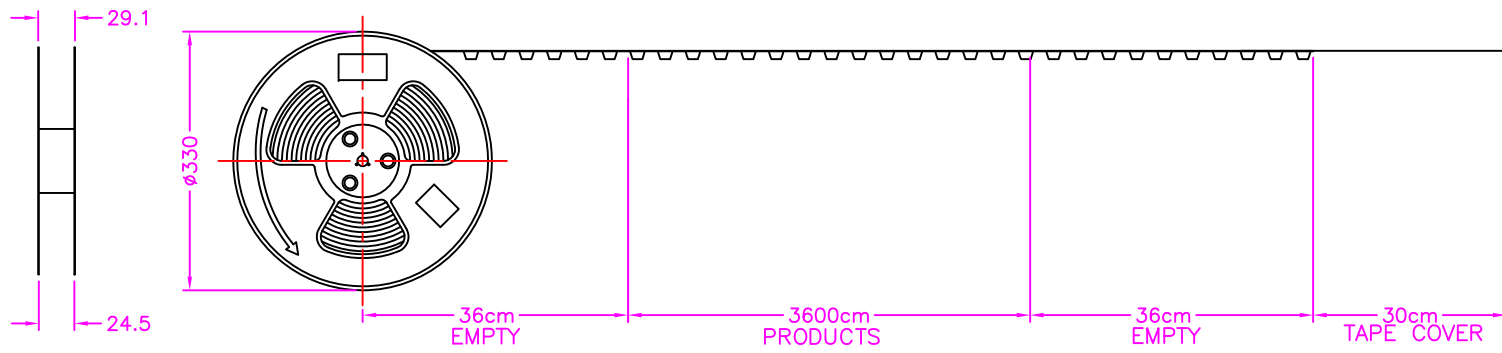

← INPUT MATERIAL DIRECTION

→ GATHER MATERIAL DIRECTION

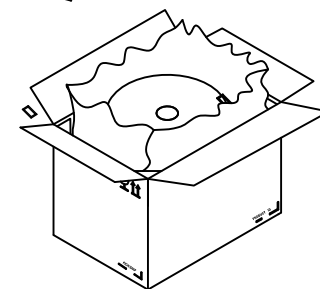
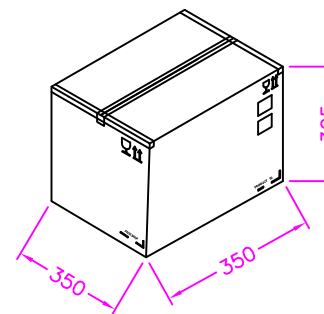
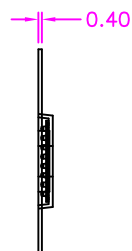
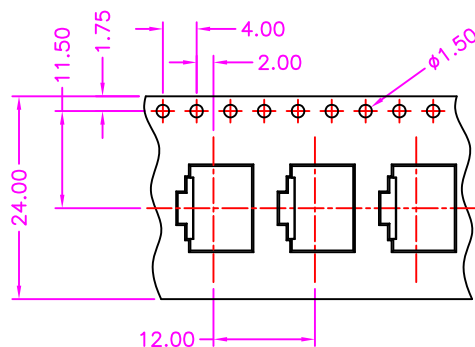
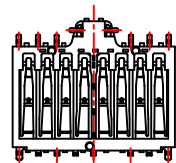

NOTE: 3000PCS/ REEL, 30000PCS/ 10 REEL/ CARTON