

P.C.B LAYOUT
TOP VIEW ±0.05

▨ SOLDER AREA
▨ KEEP OUT AREA

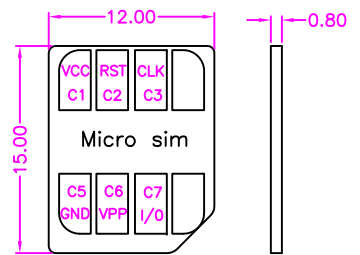

MICRO SIM CARD

MATERIALS
 HOUSING: HI-TEMP. PLASTIC (UL 94V-0), BLACK
 SHELL: STAINLESS STEEL, NICKEL PLATING
 SOLDER PAD: STAINLESS STEEL, GOLD PLATING
 TERMINAL: COPPER ALLOY, GOLD PLATED

SPECIFICATION
 CURRENT RATING: 0.5 AMP MAX
 DIELECTRIC WITHSTANDING: 500V AC FOR ONE MINUTE
 CONTACT RESISTANCE: 100m OHMS MAX
 INSULATION RESISTANCE: 1000M OHMS MIN AT DC 500V
 OPERATION TEMPERATURE: -40°C~+85°C

PART NUMBER:
MMCQD - 0 8 * - 1 2 6

SERIES ——— NO. OF POS. ——— TAPE REEL PACKAGE

CONTACT PLATED OPTION

1: GOLD FLASH
 3: 3u" GOLD
 5: 5u" GOLD
 6: 10u" GOLD
 7: 15u" GOLD
 9: 30u" GOLD

Connector Pin Assignment

PIN Name	Description
C1	Vcc of SIM
C2	RST of SIM
C3	CLK of SIM
C5	GND of SIM
C6	Vpp of SIM
C7	I/O of SIM

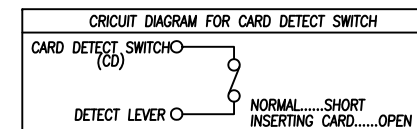

TOLERANCES

X.±0.40	.XX±0.20
.X±0.30	.XXX±0.10

REV.	A	DRAWN BY	Zhong 2018/12/5	TITLE	MICRO SIM CARD, 8PIN, PCB MOUNT, SMT, METAL SHIELD, PUSH PUSH TYPE H=1.42mm, FEMALE
		APPROVED BY	Lion 2018/12/5	DRAW NO.	MMCQD-006

UNIT	MM	Sheet	1/2
------	----	-------	-----

1

2

3

4

5

6

A

A

B

B

C

C

D

D

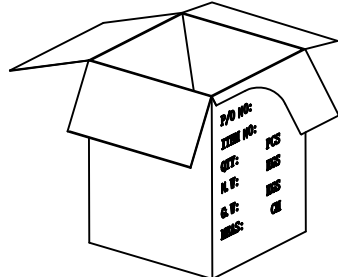
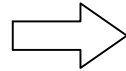
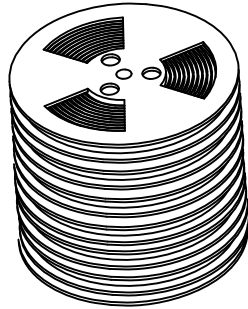
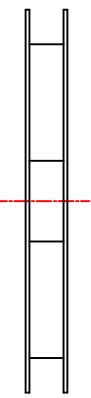
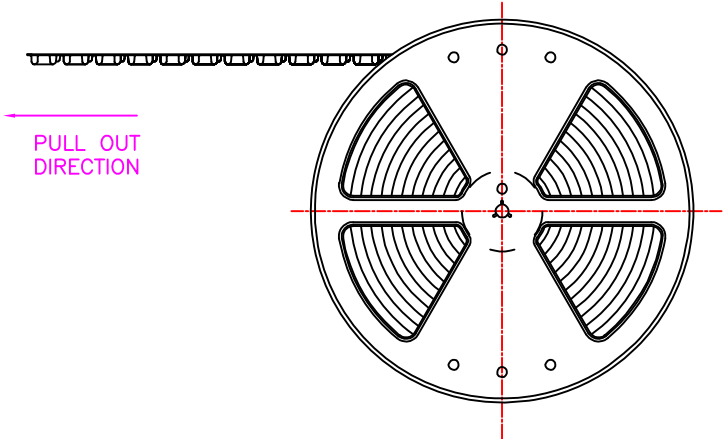
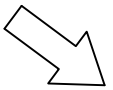
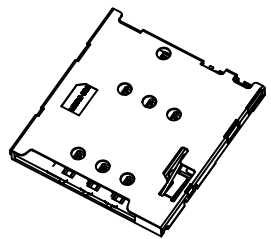

NOTE: 1000PCS/ REEL, 5000PCS/ 5 REEL/CARTON

Z ZICONN
ELECTRONIC CO., LTD.
WWW.ZICONN.COM 886-3-4687695

TOLERANCES	
X.±0.40	.XX±0.20
.X±0.30	.XXX±0.10

REV.	A	DRAWN BY	Zhong 2018/12/5
		APPROVED BY	Lion 2018/12/5

TITLE	MICRO SIM CARD, 8PIN, PCB MOUNT, SMT, METAL SHIELD, PUSH PUSH TYPE H=1.42mm, FEMALE				
DRAW NO.	MMCQD-006	UNIT	MM	Sheet	2/2

1

2

3

4

5

6