

**MATERIALS**

HOUSING: HI-TEMP. PLASTIC (UL 94V-0), BLACK  
 CAP: HI-TEMP. PLASTIC (UL 94V-0), BLACK  
 SHELL: STAINLESS STEEL, NICKEL PLATING  
 TERMINAL: COPPER ALLOY, GOLD PLATED

**SPECIFICATION**

CURRENT RATING: 1.8 AMP MAX (ONLY PIN 1, 5), OTHER 1 AMP MAX  
 DIELECTRIC WITHSTANDING: 250V AC FOR ONE MINUTE  
 CONTACT RESISTANCE: 50m OHMS MAX  
 INSULATION RESISTANCE: 100M OHMS MIN AT DC 500V  
 OPERATION TEMPERATURE: -40°C~+85°C

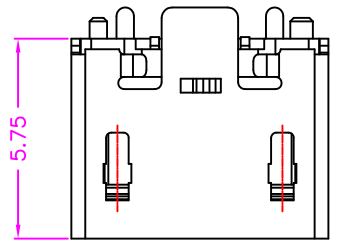

WITHOUT FLANGE

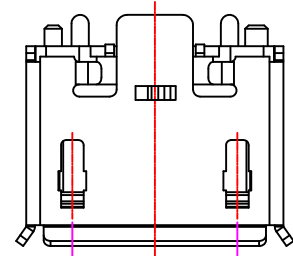

WITH FLANGE

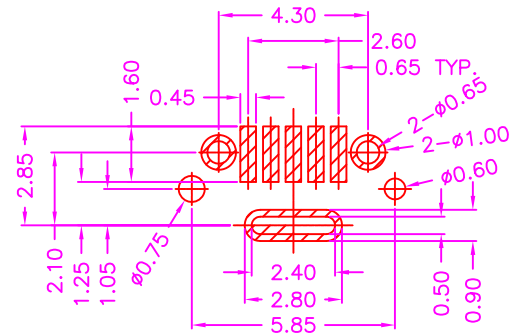
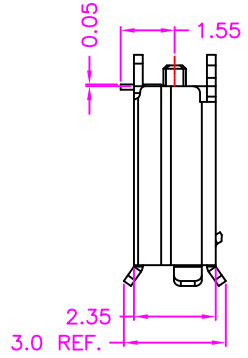
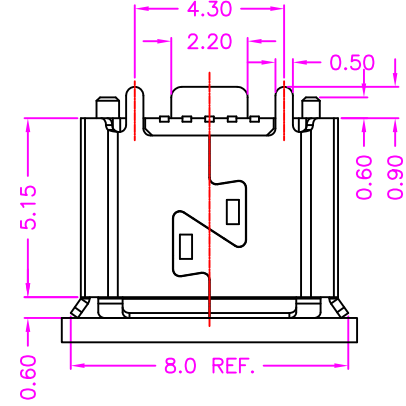

P.C.B LAYOUT  
TOP VIEW ±0.05

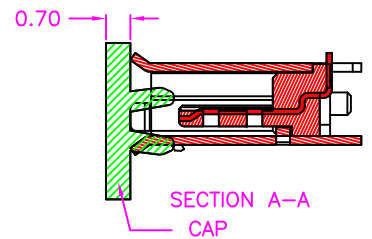
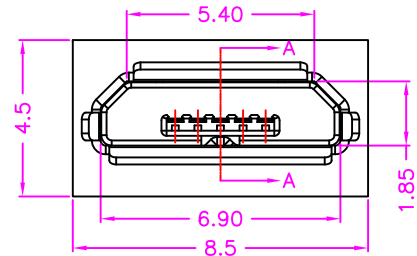

PART NUMBER:  
BUSTJ - 0 5 \* - 1 \* 2 \*

SERIES  
NO. OF POS.

FLANGE OPTION  
BLANK: W/O FLANGE  
F: WITH FLANGE

CONTACT PLATED OPTION

- 1: GOLD FLASH
- 3: 3u" GOLD
- 5: 5u" GOLD
- 6: 10u" GOLD
- 7: 15u" GOLD
- 9: 30u" GOLD

- PACKAGE OPTION
- 1. TRAY
  - 2. TAPE REEL

CONTACT NUMBER	SIGNAL NAME
PIN 1	VCC
PIN 2	D-
PIN 3	D+
PIN 4	ID
PIN 5	GND



TOLERANCES  
 X.±0.40 .XX±0.20  
 .X±0.30 .XXX±0.10

REV. A

DRAWN BY Zhong 2018/5/24  
 APPROVED BY Lion 2018/5/24

TITLE MICRO USB B TYPE, PCB MOUNT, VERTICAL SMT, METAL SHIELD, FEMALE  
 DRAW NO. BUSTJ-002 UNIT MM Sheet 1/1