

P.C.B LAYOUT
TOP VIEW ±0.05

MATERIALS

HOUSING: THERMOPLASTIC (UL 94V-0), BLACK
 INNER PIN: COPPER ALLOY
 TERMINAL: COPPER ALLOY

SPECIFICATION

CURRENT RATING: 20V, 3.5 AMP MAX. (PBT)
 50V, 3.5 AMP MAX. (PA9T)
 DIELECTRIC WITHSTANDING: 500V AC FOR ONE MINUTE
 CONTACT RESISTANCE: 50m OHMS MAX
 INSULATION RESISTANCE: 100M OHMS MIN AT DC 500V
 OPERATION TEMPERATURE: -40°C~+85°C

TABLE

CIRCUIT	
A	B

PART NUMBER:

JPJAA - * * * * - 1 * 1

SERIES — JPJAA
 INNER PIN OPTION — * * * *
 2: Ø2.50mm
 4: Ø2.00mm
 CIRCUIT OPTION — *
 REF. TABLE
 PACKAGE OPTION — 1 * 1
 1: TRAY
 4: BAG
 HOUSING MATERIAL OPTION — *
 BLANK: PBT
 P9: PA9T
 TERMINAL PLATING OPTION — *
 BLANK: TIN
 S: SILVER



TOLERANCES

X.±0.40	.XX±0.20
.X±0.30	.XXX±0.10

REV.	A	DRAWN BY	Zhong 2017/11/29	TITLE	DC POWER JACK, PCB MOUNT, R/A				
		APPROVED BY	Lion 2017/11/29	DRAW NO.	JPJAA-001	UNIT	MM	Sheet	1/1

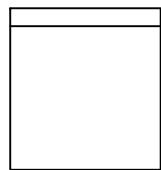
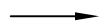
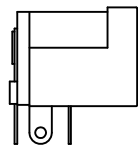

BAG

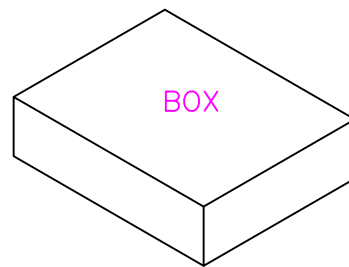
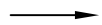

BOX

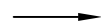
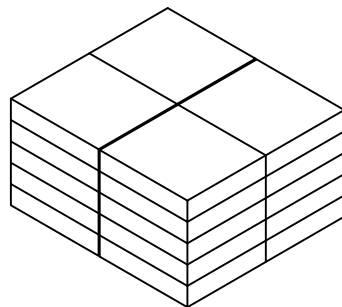
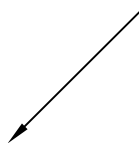

PE BAG

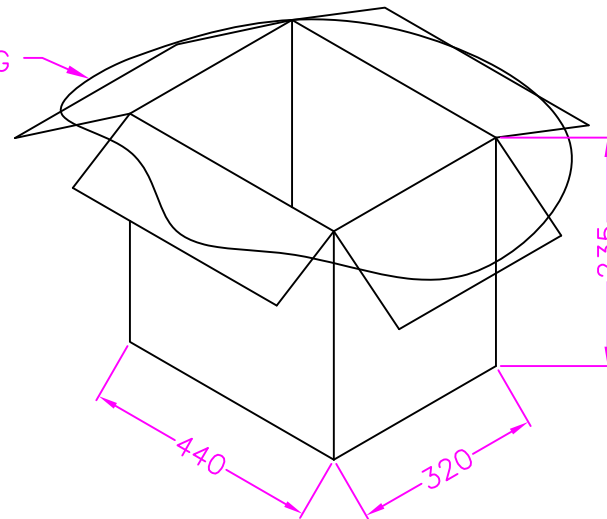

NOTE: 500PCS/BAG, 10000PCS/ 20 BOX/ CARTON